

# CNC PROFI

## Schutz gegen elektrische Störung

240V 50Hz

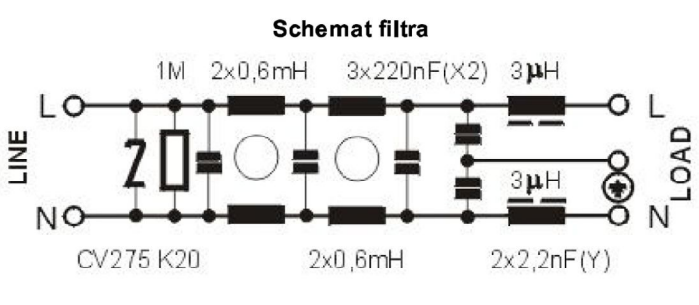
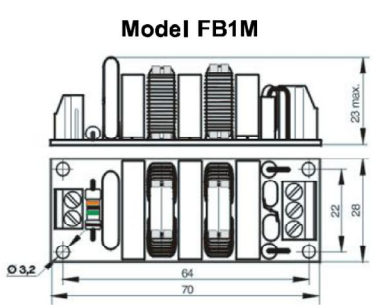
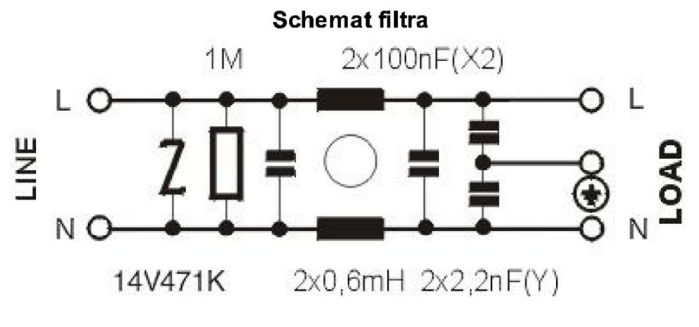
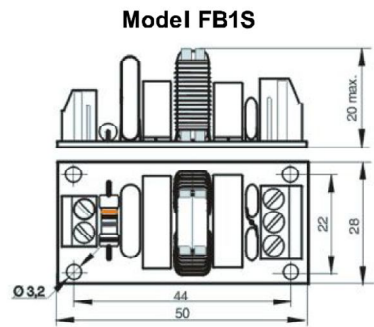
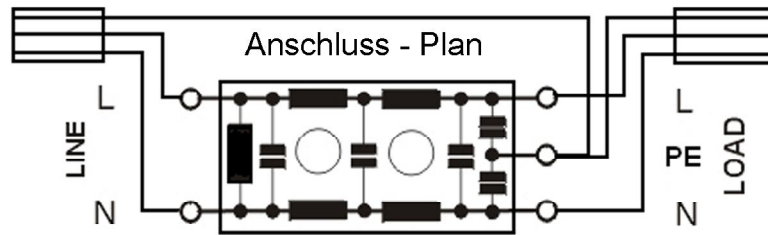

### Charakterystyki

Asymetryczne (Asymmetrical)

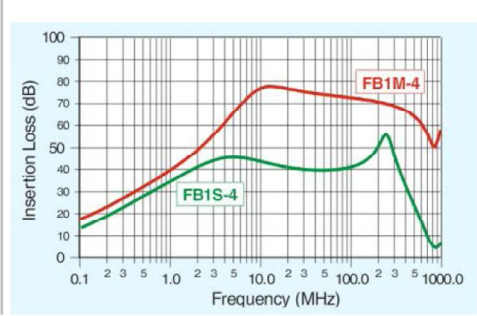
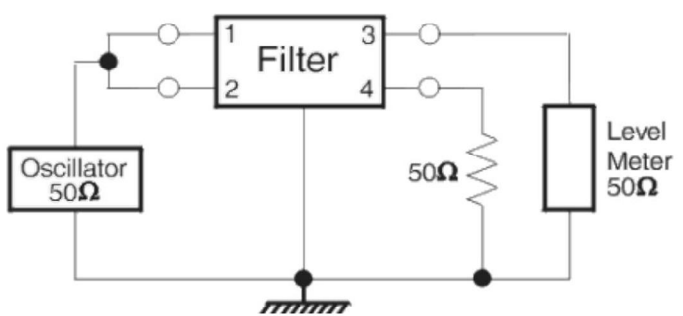

Symetryczne (Symmetrical)

